

Molecular Coding Format manual

Akira Yamaji

April 4, 2021

Located at <http://www.ctan.org/pkg/mcf2graph>

Suggestion or request mail to: mcf2graph@gmail.com

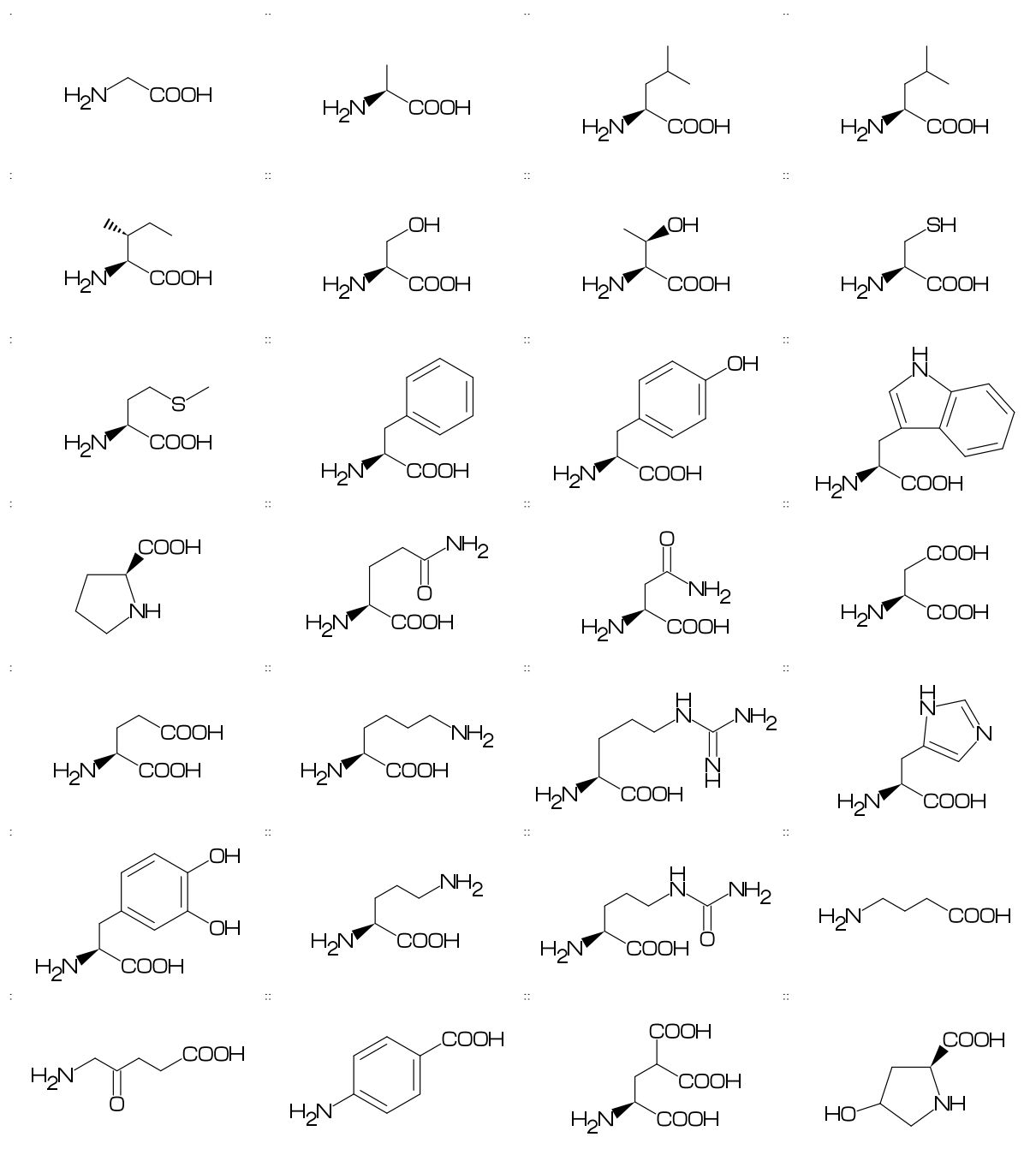

Contents

1	Introduction	3
2	MCF syntax	3
2.1	Make bond	3
2.1.1	Chain	3
2.1.2	Chain use !,ln	3
2.1.3	Jump to atom	3
2.1.4	Branch bond	3
2.1.5	Branch modified bond	3
2.1.6	Connect atom	3
2.1.7	Ring	3
2.1.8	Rotate current angle	3
2.2	Change bond type	4
2.2.1	Double,triple,wedge,vector	4
2.2.2	Change multiple bond type	4
2.2.3	Over line	4
2.3	Change bond length	4
2.3.1	Chain length	4
2.3.2	Ring length	4
2.4	Change atom	4
2.4.1	Insert atom	4
2.4.2	Addressed atom	5
2.4.3	Brock address	5
2.4.4	Reset brock address	5
2.4.5	Absolute address	5
2.4.6	Relative address	5
2.4.7	Charged atom	5
2.5	Fuse ring	5
2.5.1	Attached 1 bond	5
2.5.2	Attached 2 bond	5
2.5.3	Attached 3 bond	6
2.5.4	Attached 4 bond	6
2.5.5	Spiro ring	6
2.6	Group	6
2.6.1	Insert group	6
2.6.2	Insert modified group	6
2.6.3	Add group	6
2.6.4	Add modified group	6
2.7	Chain environment	7
2.7.1	Horizontal,vertical	7
2.7.2	Left-right,right-left	7
2.7.3	Fixed rotate angle	7
2.7.4	Multi rotate angle	7
2.8	Miscellaneous	7
2.8.1	Abbreviated parts	7
2.8.2	Parts definition	7
2.8.3	Parts inline definition	7
2.8.4	Move position	7
2.8.5	Change color	8
2.8.6	Change font	8
3	Option parameter	8
3.1	Angle parameter	8
3.2	Size/Ratio parameter	8
3.2.1	Bond length	8
3.2.2	Molecular size	8
3.2.3	Molecular position	8
3.3	Size parameter	9
3.3.1	Font size	9
3.3.2	Font margin	9
3.3.3	Offset thickness of bond	9
3.3.4	Offset of double bond gap	9
3.3.5	Offset of atom width	9
3.3.6	Offset of wedge width	9
3.3.7	Max bond length	9
3.4	Ratio parameter	9
3.4.1	Thickness/bond length	9
3.4.2	Char/bond thickness	9
3.4.3	Bond gap/bond length	9
3.4.4	Atom/bond length	9
3.4.5	Wedge/bond length	9
3.4.6	Font atom gap/atom length	9
3.4.7	Chain/ring length	9
3.4.8	Hash gap/bond length	9
3.5	Drawing mode	10
3.5.1	Numbering atom	10
3.5.2	Numbering bond	10
3.5.3	Trimming mode	10
3.5.4	Expand mode	10
3.5.5	Group off mode	10
3.5.6	Single bond mode	10
3.6	Frame	10
3.6.1	Font frame	10
3.6.2	Molecular frame	10
3.6.3	Atom frame	10
3.7	Parameter setting	11
3.7.1	Local parameter setting	11
3.7.2	Global parameter setting	11
4	Function	11
4.1	Function MC()	11
4.2	Function MCat()	11
4.3	Function check()	11
4.4	Function add()	12
4.5	Function ext()	13
4.5.1	Local ext() setting	13
4.5.2	Global ext() setting	13
5	MCF example	14
5.1	Luciferin	14
5.2	Colchicine	14
5.3	Paclitaxel	14
5.4	Lycorine	14
5.5	Gibberellin	14
5.6	Quinine	14
6	Example to use mcf2graph	15
6.1	Metafont/Metapost source file	15
6.2	Molecular data base file	16
6.3	Information auxfile output	17
6.4	Report output	18
6.5	MOL file output	19
6.6	LuaTeX file example	20
6.7	LaTeX file example	21

1 Introduction

Molecular Coding Format(MCF) is new linear notation represent chemical structure diagrams. This Coding is named from programming technique such as operator, array, scope, macro, addressing, etc. mcf2graph convert from MCF to pk font, PNG, SVG, EPS, MOL file. It is also able to calculate molecular weight, exact mass, molecular formula.

2 MCF syntax

2.1 Make bond

2.1.1 Chain

real number plus (+): counterclockwise
real number minus(-): clockwise
\$n (0<=n<360): absolute angle

<10,-30,45,-45,60,\$300,\$0

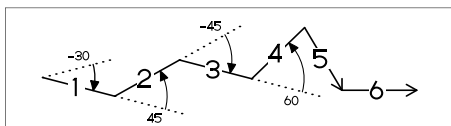

2.1.2 Chain use !,!n

! : take value 60 or -60 depend on current angle and environment
!6 : !,!,!,!,!,!

<-30,!6

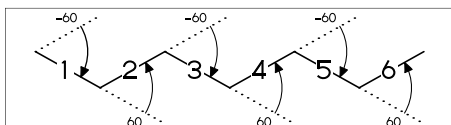

2.1.3 Jump to atom

@n : Jump to An
** An: atom number(-999<=n<=4095)

<-30,!6,@3,0,!,@5,-30

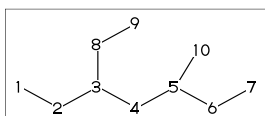

2.1.4 Branch bond

\ : 0

<-30,!6,@3,\,!

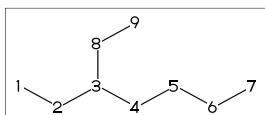

2.1.5 Branch modified bond

\ : 0
*\ : 0~wf
* : 0~zf
\ \ : 0~dm
** : 0~wv

<30,!8,
@2,\,!,@4,*\,!,@6,*,!,@8,\ \,!,@10,**,!

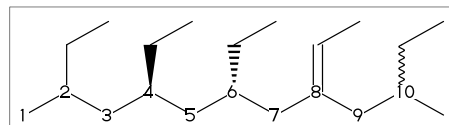

<30,!6,
\~dr,! : 0~dr,!
\'1.5,-90 : 0'1.5,-90
\^15,-60 : 0^15,-60

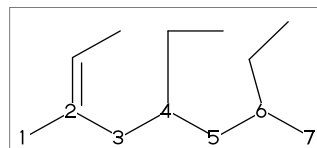

2.1.6 Connect atom

&n : Connect to An

<-30,!6,@3,\,!3,&6~bd,@9,&4~bz

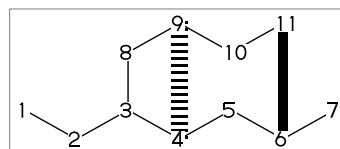

2.1.7 Ring

?n : n membered ring(3<=n<=20)
?6 : <-120,60,60,60,60,60,&1
?6

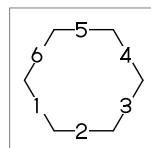

2.1.8 Rotate current angle

<angle : rotate current angle

0,0,<90,0,<-90,0,<\$315,0,<\$90,0,<\$0,0

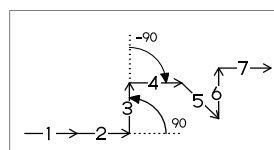

2.2 Change bond type

2.2.1 Double, triple, wedge, vector

(Double, triple)

```
a~type : ~type,a
dm : double middle
dl : double left side
dr : double right side
db : double left or right side
tm : triple
!! : !~db / !!! : !~tm

<-30,!~dm,!~dl,!~dr,!~db,!~db,!~tm
<-30,!~dm,!~dl,!~dr,!! ,!! ,!,!!!
```

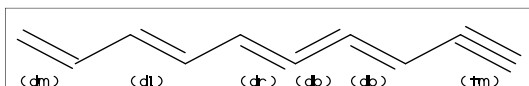

(Wedge)

```
wf: wedge forward
wb: wedge backward
zf: hashed(zebra stripe) wedge forward
zb: hashed(zebra stripe) wedge backward
```

```
<-30,!~wf,!~wb,!~zf,!~zb
```

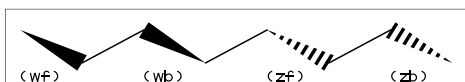

(Vector)

```
vf:vector forward
vb:vector backward
```

```
<-30,!~vf,!~vb
```

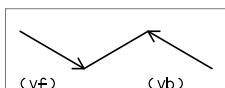

(Dotted, wave)

Bn=bond type : change bond type at Bn

```
dt : dotted
wv : wave
bd : broad
bz : broad dotted
```

```
<-30,!7,1=dt,3=wv,5=bd,7=bz
```

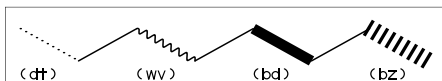

2.2.2 Change multiple bond type

```
{2,4,6}=dr : 2=dr,4=dr,6=dr
```

```
<30,!7,{2,4,6}=dr
```

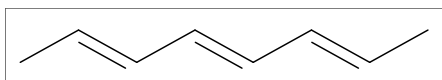

2.2.3 Over line

```
si_ : single over line
wf_ : wedge forward over line
wb_ : wedge backward over line
zf_ : hashed wedge forward over line
zb_ : hashed wedge backward over line
bd_ : broad over line
dl_ : duple left over line
dr_ : duple right over line
dm_ : duple over line
```

```
<30,!8,!60,90'18,
{2~si_,4~wf_,6~wb_,8~zf_,10~zb_,
12~bd_,14~dl_,16~dr_,18~dm_}/_ '2
```

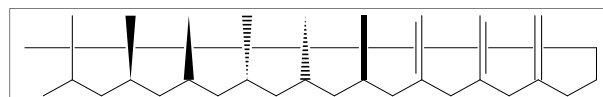

2.3 Change bond length

2.3.1 Chain length

```
(!,!n)'length : change length of !,!n
```

```
<-30,!2,!4'1.2,!2
```

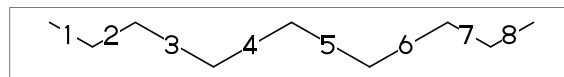

```
#n : bond length=n
```

```
## : reset bond length
```

```
<-30,!2,#1.2,!4,##,!2
```

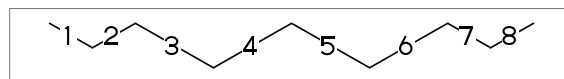

2.3.2 Ring length

```
?n'length : change ring length
```

```
?6,@4,\,?6'1.2
```

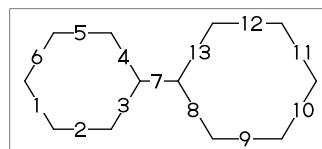

2.4 Change atom

2.4.1 Insert atom

Insert hetero atom

```
<-30,!2,0,!2,N,!2
```

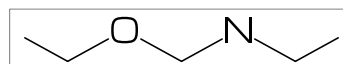

2.4.2 Addressed atom

2:0 : change A2 C to O
{3,4}:N : change A3,A4 C to N

<30,14,2:0,{3,4}:N

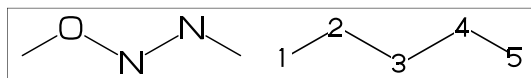

2.4.3 Brock address

| : divide brock

?6,@4,\,|,?6,2:0

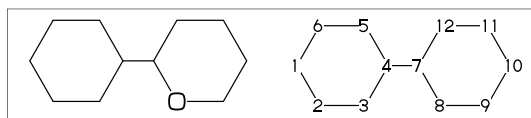

2.4.4 Reset brock address

|| : reset brock address

?6,@4,\,|,?6,||,2:N

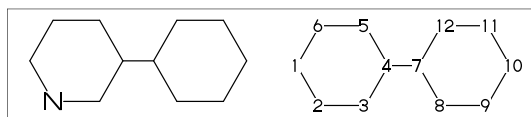

2.4.5 Absolute address

\$2:N : change A\$2 C to N **1<=n<=3095

?6,@4,\,|,?6,\$2:N

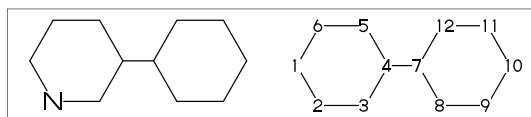

2.4.6 Relative address

-2:N : change A(-2) C to N ** -999<=n<=-1

?6,@4,\,?6,-2:N

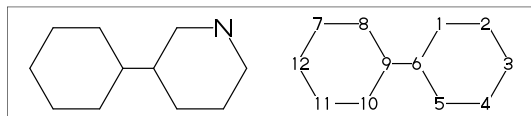

2.4.7 Charged atom

p_ : positive / n_ : negative

<-30,!2,N,??,p_,!2,S,n^180,
!6,7:N,7:??,9:S,7:n_,9:n^180

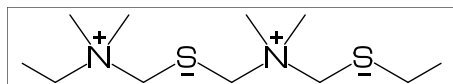

2.5 Fuse ring

2.5.1 Attached 1 bond

?6,3=?6 : fuse ?6 at B3

** Bn(n:-999<=n<=4095): bond number

?6,3=?6

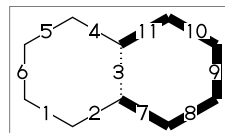

** fused ring size depend on
attached bond length

?6,@4,\,?6'1.2,5=?6,11=?6

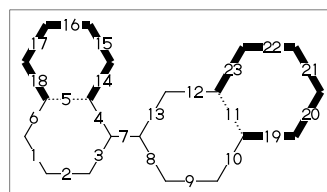

?6,3=?6[13] : fuse ?6[13] at B3

?6[13]: 6 membered ring scaled 13/10

** ?m[n] (5<=m<=8,11<=n<=15)

?6,3=?6[13]

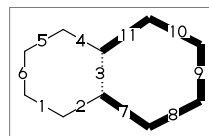

?6,{-3,-4,-4,-2,-2,-4,-4}=?6

?6,{4,8,13,20,25,28,33}=?6

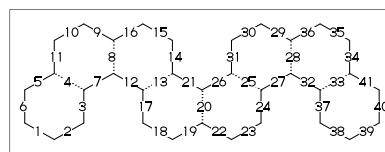

2.5.2 Attached 2 bond

(4,11)=?6[4] : fuse 4/6 ring to B11..B4

(4,11)=?5[3] : fuse 3/5 ring to B11..B4

(4,11)=?4[2] : fuse 2/4 ring to B11..B4

** ?m[n] (4<=m<=6,n=m-2)

1:<30,?6,3=?6,(11,4)=?6[4]

2:<30,?6,3=?6,(11,4)=?5[3]

3:<30,?6,3=?6,(11,4)=?4[2]

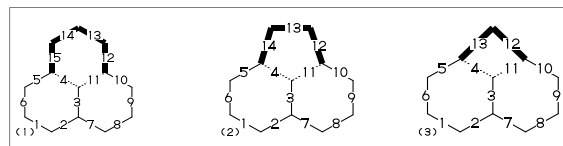

2.5.3 Attached 3 bond

(16,4)=?6[3] : fuse 3/6 ring to B16..B4
 (16,4)=?5[2] : fuse 2/5 ring to B16..B4
 ** ?m[n] (5<=m<=6,n=m-3)

1:?6,{3,10}=?6,(16,4)=?6[3]
 2:?6,{3,10}=?6,(16,4)=?5[2]

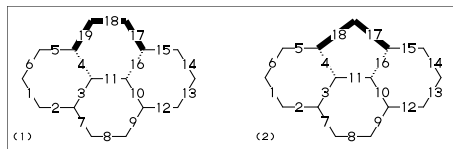

2.5.4 Attached 4 bond

(21,4)=?6[2] : fuse 2/6 ring to B21..B4

MC(<-30,?6,{3,10,15}=?6,(21,4)=?6[2])

** ?m[n] (m=6,n=2)

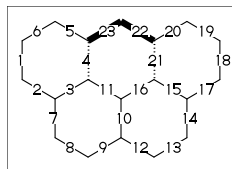

2.5.5 Spiro ring

@4,?5 : add ?5 at A4

<30,!6,@4,?5

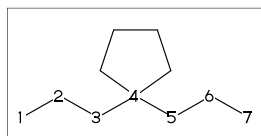

2.6 Group

2.6.1 Insert group

/ : single

<-30,!/,!,!,/!,!3,/!2,!,/?!,
 !3,/??!,!,/Ph^-30,!)

** /_ : methyl /! : ethyl
 /!2 : propyl /?! : isopropyl
 /??! : tert-butyl /Ph : phenyl

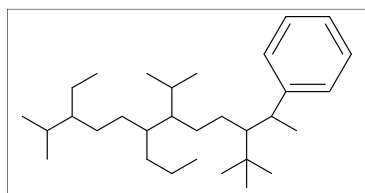

2.6.2 Insert modified group

// : double (double middle)

*/ : wedge forward

/* : hashed wedge forward

/ : wave

** : direct

<30,!/,/0,!2,*/H,!2,/*H,!2,*/*H,!2,**?3,!)

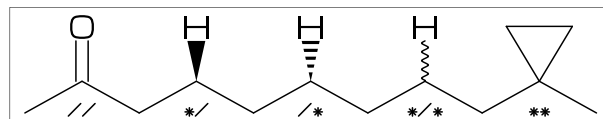

~ : change type

^ : change angle

' : change length

> : change environment

<-30,'^1,!,
 /_'^2^30,!2,/!2>lr,!2,/!2>r1,!)

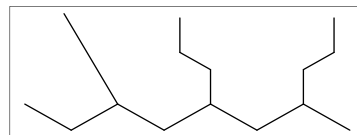

2.6.3 Add group

<30,!17,2:/_,4:/!,6:/!2,
 10:/?! ,14:/??!,16:/Ph^-60

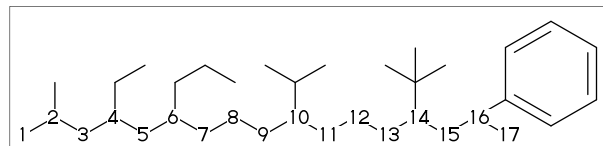

2.6.4 Add modified group

~,^,' : change type,angle,length

<30,!6,{2~wf,4~zf,6^-30,8^\$120}:/_

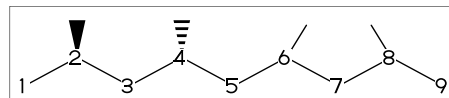

^,',> : change angle,length,environment

<-30,!7^1,3:/_'^2^30,5:/!2>lr,7:/!2>r1

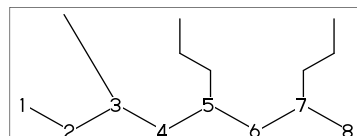

2.7 Chain environment

2.7.1 Horizontal,vertical

>hz : horizontal environment (default)
>vt : vertical environment

```
?4,  
{3^-90,3^-30,3^90}:/'(!3,"{hz}")>hz,  
{1^-60,1,1^60}:/'(!3,"{vt}")>vt
```

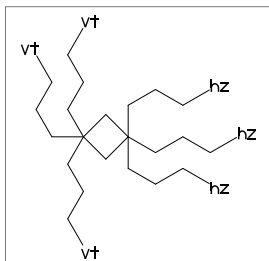

2.7.2 Left-right,right-left

>lr : left-right environment
>rl : right-left environment

```
<-30,!6,  
{3^-30,3,3^30}:/'(!3,"{lr}")>lr,  
{5^-30,5,5^30}:/'(!3,"{rl}")>rl
```

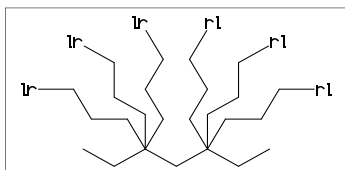

2.7.3 Fixed rotate angle

>n : rotate n

```
<30,!4,  
2:/!6>30, % 2:\,30,30,30,30,30,30  
4:/!4>-45 % 4:\,-45,-45,-45,-45
```

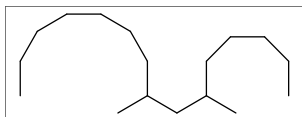

2.7.4 Multi rotate angle

>'(90,-90,...) : rotate 90,-90,...

```
<30,!6,6>'(90,-90,90,-90,90):/!5
```

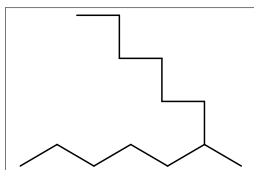

2.8 Miscellaneous

2.8.1 Abbreviated parts

```
NH : N,/H~n1  
N! : N,/_  
N!2 : N,/!  
S0 : S,//0  
S00 : S,//0^35,/^-35
```

```
<-30,!2,NH,!2,N!,!2,N!2,S0,!2,S00,!
```

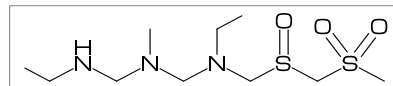

```
?! : /_,!  
?? : /_^35,/_-35  
/?! : isopropyl  
/??? : tert-butyl  
/N?! : dimethylamino
```

```
<30,!9'1,?!,! ,??,! ,  
2:??,4:/??,6:/??? ,8:/N?!
```

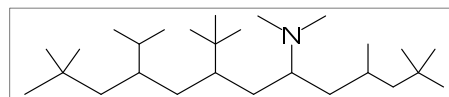

2.8.2 Parts definition

'(..) : user defined parts

```
iBuOH:='(!,/_,! ,OH);  
MC(<30,?6,{4,6}:/iBuOH)
```

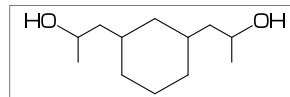

2.8.3 Parts inline definition

```
<30,! , /'(!,/_,! ,OH),!
```

```
<30,!8,{2,6}:/'(!,/_,! ,OH)
```

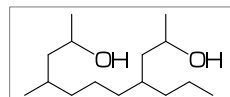

2.8.4 Move position

@(x,y) : Move to (l*x,l*y) from origin
** l=bond length of ring

```
<30,?6,@3,!4,//0,! ,0,n_^60,@(6,1),H,p_^15
```

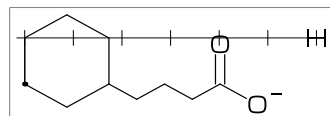

2.8.5 Change color

(use with metapost only)

```
beginfont()
  MC(<30,Ph,{2,5}:N,3:/NH2,4:/COOH,
    %-----
    2:red,      % red   A2
    5:blue,     % blue  A5
    3:green,    % green B3
    %-----
  )
endfont
```

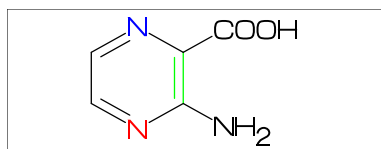

2.8.6 Change font

(use with metapost only)

```
beginfont()
  %-----
  atomfont:="cmr8";
  %-----
  MC(<30,Ph,{2,5}:N,3:/NH2,4:/COOH)
endfont
```

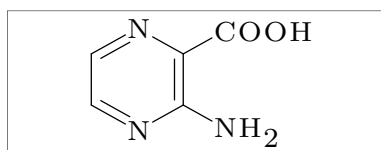

3 Option parameter

3.1 Angle parameter

mangle=0 ** default

MCat(0.2,0.5)(Ph)

mangle:=30;

MCat(0.8,0.5)(Ph)

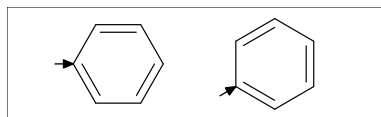

3.2 Size/Ratio parameter

3.2.1 Bond length

(fit to font size)

blength=0 ** default

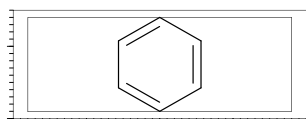

(ratio bond/font width)

blength=0.1 ** (0<blength<=1)

blength=60mm(width)*0.1=6mm

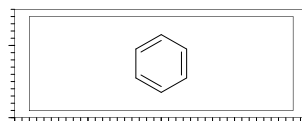

(bond length)

blength=9mm

** (blength>1) ignore msize(w,h)

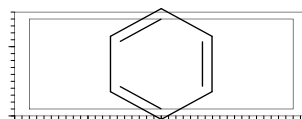

3.2.2 Molecular size

msize=(1,1) ** default

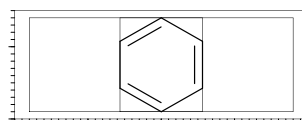

msize=(0.25,1)

msize=40mm-4mm*0.25=9mm

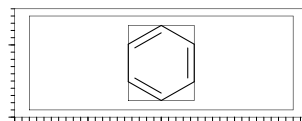

msize=(11mm,11mm)

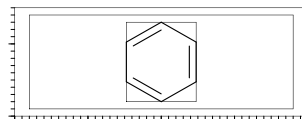

3.2.3 Molecular position

mposition=(0.5,0.5) ** default

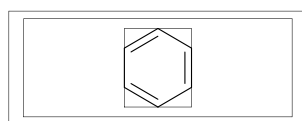

mposition=(1,0)



mposition=(10mm,4mm)

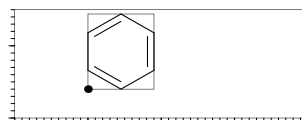

3.3 Size parameter

3.3.1 Font size

fsize=(font width,font height)
** default: (30mm,20mm)

fsize=(40mm,15mm)

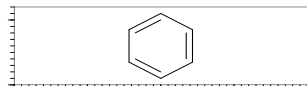

3.3.2 Font margin

fmargin=(margin left right,top bottom)
** default: (0.4mm,0.4mm)

fmargin=(10mm,2mm)

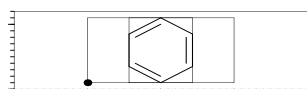

3.3.3 Offset thickness of bond

default: offset_thickness=0.2pt

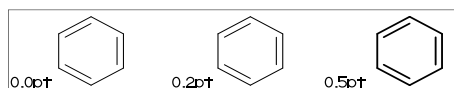

3.3.4 Offset of double bond gap

default: offset_bond_gap=0.3pt

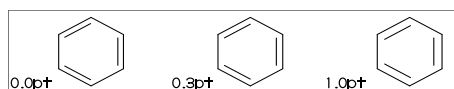

3.3.5 Offset of atom width

default: offset_atom=0.8pt

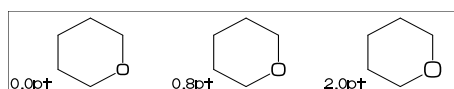

3.3.6 Offset of wedge width

default: offset_wedge=0.4pt

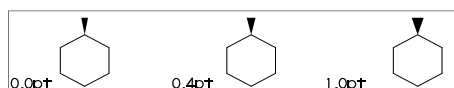

3.3.7 Max bond length

default: max_blength=10mm

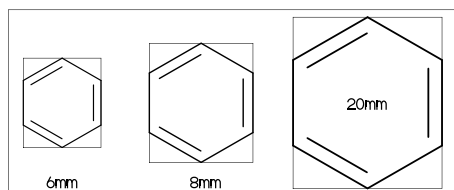

3.4 Ratio parameter

3.4.1 Thickness/bond length

default: ratio_thickness_bond=0.015

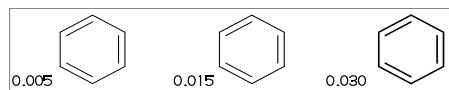

3.4.2 Char/bond thickness

default: ratio_char_bond=1.5

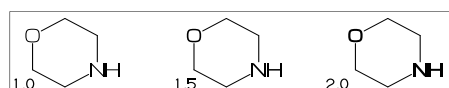

3.4.3 Bond gap/bond length

default: ratio_bondgap_bond= 0.15

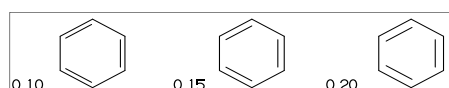

3.4.4 Atom/bond length

default: ratio_atom_bond= 0.36

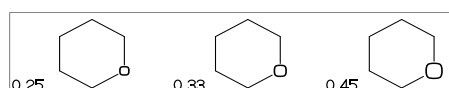

3.4.5 Wedge/bond length

default: ratio_wedge_bond=0.12

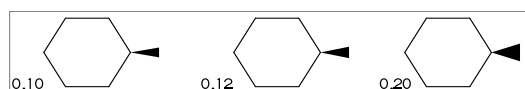

3.4.6 Font atom gap/atom length

default: ratio_atomgap_atom= 0.050

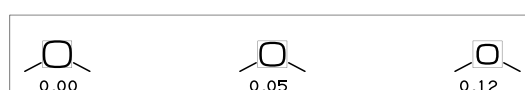

3.4.7 Chain/ring length

default: ratio_chain_ring= 0.66

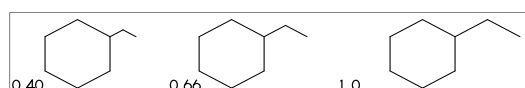

3.4.8 Hash gap/bond length

default: ratio_hashgap_bond=0.12



3.5 Drawing mode

3.5.1 Numbering atom

```
numberA_start:=3; numberA_end:=8;
default: sw_numberA=0 :
  numberA_start=1 numberA_end=4095
```

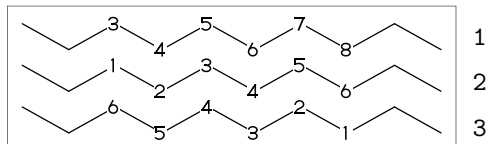

3.5.2 Numbering bond

```
numberB_start:=3; numberB_end:=8;
default: sw_numberB=0 :
  numberB_start=1 numberB_end=4095
```

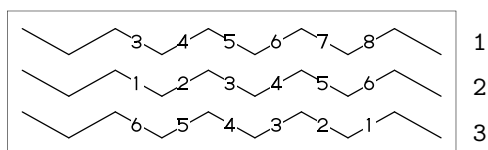

3.5.3 Trimming mode

```
sw_trimming:=0; ** default
msize:=(1,0.7);
MCat(0.2,0.3)(Ph)
MCat(0.8,0.7)(Ph)
```

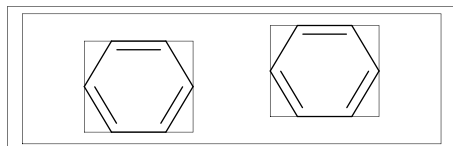

```
sw_trimming:=1;
MCat(0.2,0.3)(Ph)
MCat(0.8,0.7)(Ph)
```

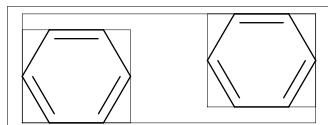

3.5.4 Expand mode

```
MCat(0, .5)(<30,Ph,4:/COOH,3:/NH2)
sw_expand:=1;
MCat(1, .5)(<30,Ph,4:/COOH,3:/NH2)
** default: sw_expand=0
```

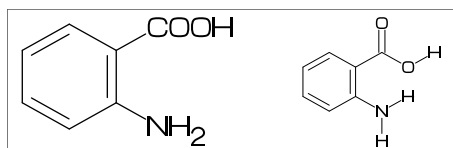

3.5.5 Group off mode

```
** default: sw_group_off=0
```



3.5.6 Single bond mode

```
** default: sw_single=0
```



3.6 Frame

3.6.1 Font frame

```
** default:sw_fframe=0
(Draw font frame)
fmargin:=(5mm,2mm);
sw_fframe=1
```

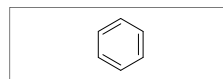

```
(Frame inside margin)
sw_fframe=2
```

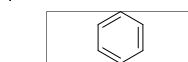

```
(Draw both frame)
sw_fframe=3
```

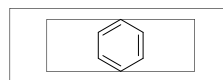

3.6.2 Molecular frame

```
sw_mframe=1
** default:sw_mframe=0
```

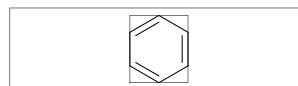

3.6.3 Atom frame

```
sw_iframe=1
** default: sw_iframe=0
```

```
MC(<30,COOH,!,COOH)
```

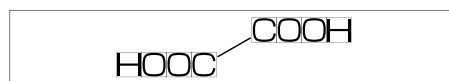

3.7 Parameter setting

3.7.1 Local parameter setting

```
beginfont()
  MC(Ph)
endfont
beginfont()
  %-----
  ratio_thickness_bond:=0.05;
  %-----
  MC(Ph)
endfont
beginfont()
  MC(Ph)
endfont
```

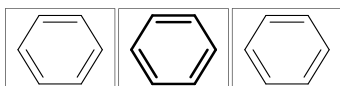

3.7.2 Global parameter setting

```
beginfont()
  MC(Ph)
endfont
%-----
ratio_thickness_bond:=0.05;
%-----
beginfont()
  MC(Ph)
endfont
beginfont()
  MC(Ph)
endfont
```

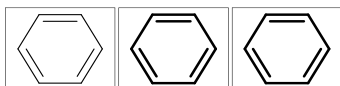

4 Function

4.1 Function MC()

(Draw molecule)

```
msize=(a,b)      **default (1,1)
mposition=(c,d)  **default (0.5,0.5)
```

a: ratio molecular width/font width
b: ratio molecular height/font height
c: x axis position
d: y axis position

```
beginfont()
  MC(<30,Ph,3:/F,4:/Cl)
endfont
```

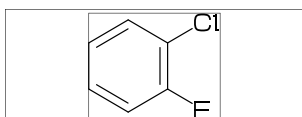

4.2 Function MCat()

(Draw molecule at mposition)

MCat(c,d)(....) :

mposition:=(c,d); MC(....)

c: x axis position
d: y axis position

```
defaultsize:=5bp;
fsize:=(60mm,40mm); fmargin:=(3mm,3mm);
blength:=0.07; sw_fframe:=1;
mangle:=0;
for i=1 step -0.5 until 0:
  for j=0 step 0.33 until 1:
    MCat(j,i)(Ph,4:N)
    add(drawarrow((A1+A1up**aw)..A1);
        label(decimal(mangle),
            p0+(0.5w,0.5h));
    )
    mangle:=mangle+30;
  endfor
endfor
```

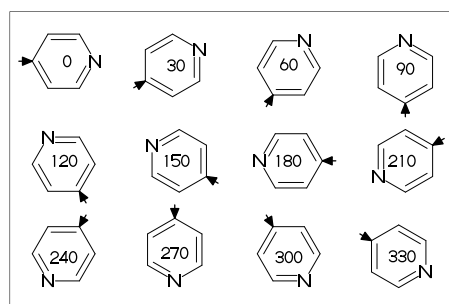

4.3 Function check()

(immediately compile)

```
beginfont("EN:Pyridine")
  MC(<30,Ph,2:N)
endfont
```

(check mcf and compile)

** check(mc) : error count

```
beginfont("EN:Pyridine",
  ":<30,Ph,}2:N") % ** extra '}'
  if check(mc)=0: MC(scantokens(mc)) fi
endfont
```



check(mc)=0



check(mc)>=1

4.4 Function add()

(Add label to molecule)

w: molecular width
h: molecular height
aw: atom font size
em: label font size
p0: origin of molecular structure
l: bond length

An: atom number
A[m]: atom position
A[m]ang: branch angle of A[m]
A[m]up: dir A[m]ang
A[m]left: dir A[m]ang+90
A[m]right: dir A[m]ang-90
A[m]down: dir A[m]ang+180

Bn: bond number
B[m]: bond(path)
B[m]s: bond start position
B[m]m: bond middle position
B[m]e: bond end position
B[m]ang: bond angle
B[m]up: dir B[m]ang
B[m]left: dir B[m]ang+90
B[m]right: dir B[m]ang-90
B[m]down: dir B[m]ang+180

plus : '+' circled
minus : '-' circled
circlediam = 0.6aw (default)
circlepen = 0.2bp (default)

lonpair r: ':' rotated r
lonpairdiam = 0.3aw (default)
lonpairspace = 0.7aw (default)

** : scaled
<< : rotated
a /* b : point b of a

```
beginfont("EN:add() 1")
  fontsize=(70mm,40mm);
  sw_aframe:=sw_mframe:=1;
  max_blength:=10mm;
  msiz=(.91,.9);
  MCat(.5,.85)(<30,?6,{2,5}:0)
  add(
    defaultscale:=.8;
    labeloffset:=.3aw;
    dotlabel.lft("p0",p0);
    dotlabel.rft("p0+(w,h)",p0+(w,h));
    dotlabel.ulft("A1",A1);
    drawarrow A1..A1+__*l<<A1ang;
    dotlabel.lrt("B3s",B3s);
    dotlabel.rft("B3m",B3m);
    drawarrow B3m..B3m+__*l<<(B3ang+90);
    dotlabel.ulft("A6",A6);
```

```
drawarrow A1{A1down}..A6;
dotlabel.urft("B3e",B3e);
label.rft("An="&decimal(An)&
  " Bn="&decimal(Bn)&
  " aw="&decimal(aw)&
  " em="&decimal(em),
  p0+(-9em,-1.5em));
label.rft("w="&decimal(w)&
  " h="&decimal(h)&
  " l="&decimal(l),
  p0+(-9em,-3em));
)
endfont
```

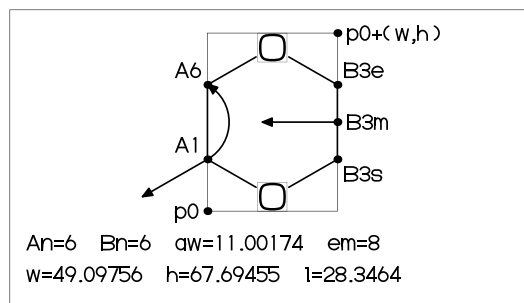

```
beginfont("EN:add() 2")
  fontsize=(60mm,20mm);
  msiz=(1,0.85);
  %-----
  MCat(0,0)(<30,Ph,3=d1,4:/NH2)
  %-----
  add(
    labeloffset:=.7aw;
    label.top(lonpair 90,A7);
    drawarrow
      (A7+up**1.2aw){A7left}
      ..{B7right}B7/*0.3;
    drawarrow
      B3m..A3+B2up**1.5aw..{A3down}A3;
  )
  %-----
  MCat(1,0)(<30,?6,{1,5}=d1,4://NH2)
  %-----
  add(
    labeloffset:=.7aw;
    label.top(plus,A7);
    label.urft(minus,A3);
    label(lonpair A3ang,A3+A3up**0.7aw);
  )
  %-----
  ext(drawdblarrow (.4w,.4h)..(.55w,.4h));
  %-----
endfont
```

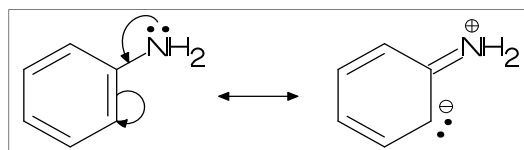

4.5 Function ext()

(Extra label to font)

```
w:   font width
h:   font height
w0:  font width-2xpart(fmargn)
h0:  font height-2ypart(fmargn)
aw:  atom font size
em:  label font size
p0:  fmargn

n:   molecular number
p[m]: molecular origin position
w[m]: molecular width
h[m]: molecular height

ratio_thickness_char:
pen thickness / char width
%-----
beginfont()
  fontsize=(70mm,30mm);
  blength:=0.065;
%-----
MCat(0.1,0.5)(
  <-210,60'1,60'1,60'1,{1,3}=d1,
  1:/R1,4:/R2^-60
)
  add(
    defaultscale:=0.6;
    label.bot("Diene",p0+(0.5w,0));
  )
MCat(0.4,0.5)(
  <-30,-60'1,1=d1,1:/R3,2:/R4^60
  add(defaultscale:=0.6;
  label.bot("Dienophile",p0+(.5w,0));
  )
MCat(0.9,0.5)(
  <30,?6,6=d1,2:/R2,3:/R4,4:/R3,5:/R1
)
%-----
ext(
  drawarrow (.52w,.5h)..(.6w,.5h);
  defaultscale:=0.7;
  label("+", (0.25w,0.5h));
  ratio_thickness_char:=0.125;
  label.bot("Diels-Alder Reaction",
    (.5w,h));
)
%-----
endfont
```

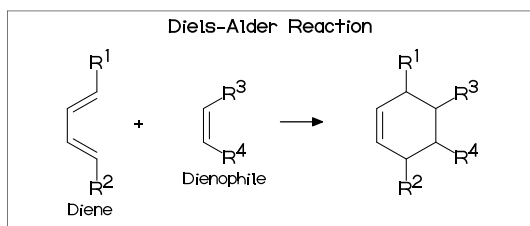

4.5.1 Local ext() setting

```
beginfont("EN:?3")
  fontsize=(12mm,15mm);
  MCat(0.5,1)(<30,?3)
endfont
beginfont("EN:?4")
  fontsize=(12mm,15mm);
  MCat(0.5,1)(?4)
%-----
ext(label.top(inf_EN,(0.5w,0));)
%-----
endfont
beginfont("EN:?5")
  fontsize=(12mm,15mm);
  MCat(0.5,1)(?5)
endfont
beginfont("EN:?5")
  fontsize=(12mm,15mm);
  MCat(0.5,1)(?6)
endfont
```

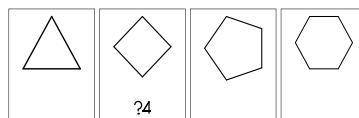

4.5.2 Global ext() setting

ext_clear: reset global ext()

```
beginfont("EN:?3")
  fontsize=(12mm,15mm);
  MCat(0.5,1)(<30,?3)
endfont
%-----
ext(label.top(inf_EN,(0.5w,0));)
%-----
beginfont("EN:?4")
  fontsize=(12mm,15mm);
  MCat(0.5,1)(?4)
endfont
beginfont("EN:?5")
  fontsize=(12mm,15mm);
  MCat(0.5,1)(?5)
endfont
%-----
ext_clear;
%-----
beginfont("EN:?6")
  fontsize=(12mm,15mm);
  MCat(0.5,1)(?6)
endfont
```

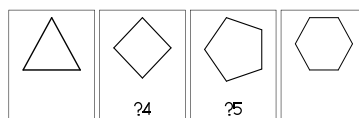

5 MCF example

5.1 Luciferin

```
(use data base file 'mcf_data_base')
beginfont("f:mcf_data_base",
          "t:EN", "v:Luciferin")
  fsize:=(50mm,15mm);
  if check(mc)=0: MC(scantokens(mc)) fi
endfont
```

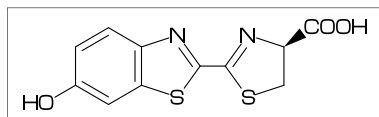

5.2 Colchicine

```
beginfont("EN:Colchicine", "MW:385.41",
          %-----
          ": <30,Ph,{1,2,6}:/O!,-4=?7,-5=?7, ",
          ": {-1,-4,-6}=d1,-2://0,-3:/O!, ",
          ": @9,\,NH,!,//0,! ")
          %-----
  fsize:=(50mm,20mm);
  if check(mc)=0: MC(scantokens(mc)) fi
endfont
```

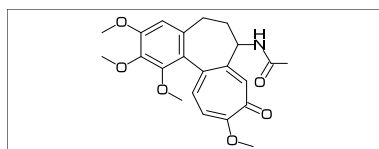

5.3 Paclitaxel

```
beginfont("EN:Paclitaxel", "MW:853.91",
          %-----
          ": ?6,5=d1,@3,#1,36,45,45,45,45,##, ",
          ": &5",
          ": -4=?6,-4=?4,-1=wb,-3=wf,-1:0,||, ",
          ": 4:??,6:/_{3~-60,15}:*/OH, ",
          ": 8:/*H^-60,",
          ": 9:*/_~60,10://0, ",
          ": @1,\,0,!//0,!*/OH,!/Ph,60~wf, ",
          ": NH,-60//0,60,Ph, ",
          ": @7,\*,0,-45//0,60,Ph, ",
          ": @11,\*,0,-60//0,60, ",
          ": @12,\*^-15,0,60//0,-60 ")
          %-----
  fsize:=(50mm,25mm);
  if check(mc)=0: MC(scantokens(mc)) fi
endfont
```

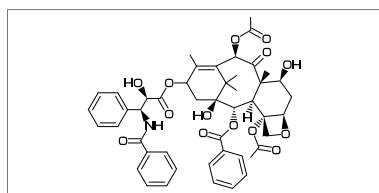

5.4 Lycorine

```
beginfont("EN:Lycorine", "MW:287.31",
          %-----
          ": Ph,-4=?6,-2=?6,6=?5,(9,12)=?5[3], ",
          ": 13=d1,8:N,{15,17}:0, ",
          ": 9:/*H^180,10:*/H^60, ",
          ": 13:*/OH,14:/*OH ")
          %-----
  fsize:=(50mm,20mm);
  if check(mc)=0: MC(scantokens(mc)) fi
endfont
```

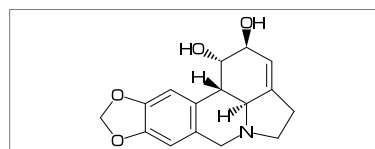

5.5 Gibberellin

```
beginfont("EN:Gibberellin A3", "MW:346.37",
          %-----
          ": <18,?5,3=?7,5=?6[12],@8,160'1.3,&3, ",
          ": 13=d1,6=wf,8=wb, ",
          ": @5,40~zf'1,0,50//0^180,&14~zb, ",
          ": 2:/COOH,7://_,13:*/OH,8:/*OH, ",
          ": 14:*/_{1,4}:*/H^60 ")
          %-----
  fsize:=(50mm,18mm);
  if check(mc)=0: MC(scantokens(mc)) fi
endfont
```

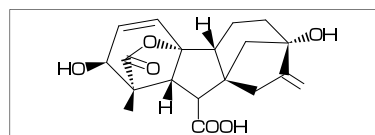

5.6 Quinine

```
beginfont("EN:Quinine", "MW:324.42",
          %-----
          ": <30,Ph,3=Ph,7:N,6:/O!, ",
          ": @10,\,*/OH,/H~zf^-60,! ",
          ": |,?6,2:N,1:*/H^60,4:*/!! ",
          ": @2,165~zf,60,&5~zb ")
          %-----
  fsize:=(50mm,20mm);
  if check(mc)=0: MC(scantokens(mc)) fi
endfont
```

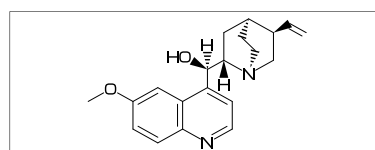

6 Example to use mcf2graph

6.1 Metafont/Metapost source file

```
%-----
input mcf2graph.mf;                                > input main macro
%-----
sw_aux_out:=1;          % aux(information) file output on > global setting
fsize:=(60mm,40mm);    % (font width,font height)      >
tag1:="J";              > jobname
tag2:="C";              > char No
tag3:="mw";             % calculated molecular weight    >
tag4:="fm";             % calculated molecular formula   >
%%%% sw_rep_out:=1;    > report output
%%%% sw_mol_out:=1;    > MOL file output
outputformat:="png";   hppp:=vppp:=0.1;                > PNG output
outputtemplate:="%j-%3c.png";                          >
%-----
beginfont("EN:Ampicillin","MW:349.405")              > information
  MC(<45,?4,-3=?5,2:N,7:S,                            > immediately compile
    3^45:/*H,1://O^15,5:/*COOH^-18,6:??,              >
    @4,*\^15,NH,!,//O,!,*NH2,! ,Ph)                  >
endfont                                                > end font
%-----
beginfont("EN:Cholesterol","MW:386.65",              >information
%-----
  ": <30,?6,{-4,-2}?6,-4=?5,7=d1,                    ", > mc1
  ": 10:/*H^180,11:/*H^-60,17:/*H^-54,              ", > mc2
  ": {4,12}:*/_^60,                                  ", > mc3
  ": @-1,18,*_,-60,!3,?!                            ") > mc4
%-----
  if check(mc)=0: MC(scantokens(mc)) fi                > mc=mc1 - mc4
endfont                                                > end font
%-----
beginfont("f:mcf_data_base","t:EN","v:Adenine")      > from mcf_data_base.mcf
  if check(mc)=0: MC(scantokens(mc)) fi                > select EN="Adenine"
endfont                                                >
%-----
beginfont("f:mcf_data_base","t:EN","v:Guanine")      > from mcf_data_base.mcf
  if check(mc)=0: MC(scantokens(mc)) fi                > select EN="Guanine"
endfont
%-----
beginfont("f:mcf_data_base","t:EN","v:Cytosine")    > from mcf_data_base.mcf
  if check(mc)=0: MC(scantokens(mc)) fi                > select EN="Cytosine"
endfont                                                >
%-----
sw_file_open:=1;          > keep file open **default sw_file_open=0
%-----
beginfont("f:mcf_data_base","t:n","v:4")             > from mcf_data_base.mcf
  if check(mc)=0: MC(scantokens(mc)) fi                > v:4 select No.4
endfont                                                >
%-----
for i=5 upto 155:                                       > from mcf_data_base.mcf
  beginfont("f:mcf_data_base","t:n","v:0")            > v:0 no selection
    if check(mc)=0: MC(scantokens(mc)) fi              > No.5 - No.155
  endfont                                                >
endfor                                                  >
%-----
bye
```

6.2 Molecular data base file

```
%%%%%%%%%%%%%%%%%%%%%%%%%%%%%%%%%%%%%%%%%%%%%%%%%%%%%%%%%%%%%%%%%%%%%%%%%
% molecular data base file mcf_data_base.mcf by Akira Yamaji 2021.04.04
%%%%%%%%%%%%%%%%%%%%%%%%%%%%%%%%%%%%%%%%%%%%%%%%%%%%%%%%%%%%%%%%%%%%%%%%%
% tag1:var1;tag2:var2;tag3:var3 ....
% first character of line '%' comment out
% first character of line '+' begin molecular definition
% first character of line '-' end molecular definition
%-----
EN:Cytosine;MW:111.10
+
<30,?6,{4,6}=d1,4:N,3://0,2:NH,5:/NH2
-----
EN:Thymine;MW:126.11
+
<30,?6,3=d1,{2,6}:NH,{1,5}://0,4:/_
-----
EN:Uracil;MW:112.09
+
<30,?6,6=d1,{3,5}://0,{2,4}:NH
-----
EN:Geraniol;MW:154.25
+
<30,!8,OH,{2,6}=dr,{2,6}:/_
-----
EN:Limonene;MW:136.24
+
<30,?6,2=d1,2:/_,@5,*\,/_,!!
-----
EN:l-Menthol;MW:156.27
+
<30,?6,2:/*?!,5:*/_ ,3:*/OH
-----
EN:Vanillin;MW:152.15
+
<30,Ph,2:/OH,3:/O!,5:/CHO
+-----
EN:Allicin;MW:162.28
+
<-30,!! ,!2,S0,! ,S,!2,!!
-----
EN:Stearic acid;MW:284.48;
+
<30,!17,COOH
-----
EN:Linoleic acid;MW:280.45
+
<30,!5,-30,-30,! ,-30,-30,!7,COOH,{6,9}=dr
-----
EN:Sphingosine;MW:299.50
+
<30,!18,OH,14=dr,-3:*/OH,-2:/*NH2
-----
EN:Tocopherol;MW:430.717
+
<30,Ph,3=?6,7:0,{1,2,5}:/_ ,8:/*_ ^60,6:/OH,@8,\ ,!12,{4,8}:/*_ ,12:/_
-----
```

6.3 Information auxfile output

(Insert option parameter setting)

```
sw_aux_out=1 : tag1:var1;tag2:var2
sw_aux_out=2 : tag1;tag2 var1;var2
** default : sw_aux_out=0
```

(Command line)

```
>mpost -s ahlength=1 FILENAME (sw_aux_out=1)
>mpost -s ahlength=2 FILENAME (sw_aux_out=2)
```

(Source)

```
beginfont("EN:Ampicillin")    .... endfont
beginfont("EN:Cholesterol")   .... endfont
beginfont("EN:Limonin")       .... endfont
beginfont("EN:beta-Carotene") .... endfont
```

(Setting)

```
tag1:="J"; tag2:="C"; tag3:="mw"; tag4:="fm"; tag5:="EN";
```

(Output)

(sw_aux_out=1)

```
F:mcf_man_soc;C:1;mw:349.40462;fm:C16H19N3O4S;EN:Ampicillin
F:mcf_man_soc;C:2;mw:386.6532;fm:C27H46O;EN:Cholesterol
F:mcf_exa_soc;C:3;mw:470.5113;fm:C26H30O8;EN:Limonin
F:mcf_exa_soc;C:4;mw:536.8722;fm:C40H56;EN:beta-Carotene
```

(sw_aux_out=2)

```
F;C;mw;fm
mcf_man_soc;1;349.40462;C16H19N3O4S;Ampicillin
mcf_man_soc;2;386.6532;C27H46O;Cholesterol
mcf_exa_soc;3;470.5113;C26H30O8;Limonin
mcf_exa_soc;4;536.8722;C40H56;beta-Carotene
```

(aux_delimiter="/")

```
F:mcf_man_soc/C:1/mw:349.40462/fm:C16H19N3O4S/EN:Ampicillin
F:mcf_man_soc/C:2/mw:386.6532/fm:C27H46O/EN:Cholesterol
F:mcf_exa_soc/C:3/mw:470.5113/fm:C26H30O8/EN:Limonin
F:mcf_exa_soc/C:4/mw:536.8722/fm:C40H56/EN:beta-Carotene
```

(Tag)

```
J : jobname
C : char number
NO : serial number
EN : english name
JN : japanese name
FM : formula from literature data
MW : molecular weight from literature data
MI : monoisotopic mass from literature data
USE : the use
mw : molecular weight calculated
mi : monoisotopic mass calculated
fm : molecular formula calculated
w : font width
h : font height
```

6.4 Report output

(Insert option parameter setting)

```
sw_rep_out:=1;  
** default : sw_rep_out=0
```

(Command line)

```
>mpost -s ahlength=3 FILENAME
```

(Output)

```
=====
No.    3 / Name = Cytosine
-----
<30,{?6,{4,6}=d1,4:N,3://0,2:NH,5:/NH2
-----
row= 1 / length= 37 / commands= 7
{}=X = 1 / {}:X = 0 / '() = 0 / @ = 0 / & = 0 / < = 1
-----
Warnings = 0 / Code= 60
Width * Height = 34.68852 * 47.4036
Shift width * height = 0 * -14.46167
Bond length = 12.75589 Atom size = 5.38914
Atom count= 9 Bond count= 9 Ring count= 1 Hide H count= 2
-----
< NO. ><atom(s) >( x axis , y axis )<bond><hideH><chg>
A1 C ( 0 , 0 ) 3 1
A2 N ( 0.866 , -0.5 ) 3
A3 C ( 1.732 , 0 ) 4
A4 N ( 1.732 , 1 ) 3
A5 C ( 0.866 , 1.5 ) 4
A6 C ( 0 , 1 ) 3 1
A7 O ( 2.508 , -0.448 ) 2
A8 H ( 0.866 , -0.922 ) 1
A9 NH2 ( 0.866 , 2.371 ) 1
-----
< NO. >< bond (sdt)><angle +( +- )><length ( pt )>
B1 1 -> 2 ( 1 ) 330 ( -30 ) 1 ( 12.76)
B2 2 -> 3 ( 1 ) 30 ( 30 ) 1 ( 12.76)
B3 3 -> 4 ( 1 ) 90 ( 90 ) 1 ( 12.76)
B4 4 -> 5 ( 2 ) 150 ( 150 ) 1 ( 12.76)
B5 5 -> 6 ( 1 ) 210 ( -150 ) 1 ( 12.76)
B6 6 -> 1 ( 2 ) 270 ( -90 ) 1 ( 12.76)
B7 3 -> 7 ( 2 ) 330 ( -30 ) 0.66 ( 8.42)
B8 2 -> 8 ( 1 ) 270 ( -90 ) 0.36 ( 4.59)
B9 5 -> 9 ( 1 ) 90 ( 90 ) 0.66 ( 8.42)
-----
<atom>( atom wt ) [ mi wt ] < cnt > < sum wt > [ sum mi wt ]
C ( 12.0107 ) [ 12 ] * 4 48.04279 [ 48 ]
H ( 1.00793 ) [ 1.00783 ] * 5 5.03967 [ 5.03914 ]
N ( 14.0067 ) [ 14.00307 ] * 3 42.0201 [ 42.0092 ]
O ( 15.9994 ) [ 15.99492 ] * 1 15.9994 [ 15.99492 ]
Molecular Weight [Mono Isotopic] = 111.1019 [ 111.04326 ]
-----
Weight Calc: 111.1019 / Input: 111.10 / weight gap= 0.00195
Fomula Calc: C4H5N3O / Input:
=====
```

6.5 MOL file output

(Insert option parameter setting)

```
sw_mol_out:=1;      % MOL(V2000)
sw_mol_out:=2;      % MOL(V3000)
** default : sw_mol_out=0
```

(Command line)

```
>mpost -s ahlength=5 FILENAME      % MOL(V2000)
>mpost -s ahlength=6 FILENAME      % MOL(V3000)
```

(Output)

%%%

-MCFtoMOL- EN:Caffeine

```
14 15 0 0 0 0 0 0 0 0999 V2000
      0      0      0 C  0 0 0 0
  0.86603    -0.5      0 N  0 0 0 0
  1.73206      0      0 C  0 0 0 0
  1.73206      1      0 C  0 0 0 0
  0.86603     1.5      0 C  0 0 0 0
      0      1      0 N  0 0 0 0
  2.6831   -0.30902    0 N  0 0 0 0
  3.27089      0.5      0 C  0 0 0 0
  2.6831    1.30902    0 N  0 0 0 0
  0.86603   -1.36383    0 C  0 0 0 0
 -0.76894    1.44394    0 C  0 0 0 0
 -0.76894   -0.44394    0 D  0 0 0 0
  0.86603    2.36383    0 D  0 0 0 0
  2.95299    2.1396    0 C  0 0 0 0
  1  2  1  0      0  0
  2  3  1  0      0  0
  3  4  2  0      0  0
  4  5  1  0      0  0
  5  6  1  0      0  0
  6  1  1  0      0  0
  3  7  1  0      0  0
  7  8  2  0      0  0
  8  9  1  0      0  0
  9  4  1  0      0  0
  2 10  1  0      0  0
  6 11  1  0      0  0
  1 12  2  0      0  0
  5 13  2  0      0  0
  9 14  1  0      0  0
```

M END

%%%

6.6 LuaTeX file example

```

\documentclass{article}
\usepackage{luamplib}%
\usepackage[T1]{fontenc}%
\usepackage{textcomp}%
\mplibcodeinherit{enable}%
\mplibverbatim{enable}%
\mplibnumbersystem{double}%
\everymplib{%
  if unknown Ph1: input mcf2graph.mf; fi
  sw_calc:=1; sw_fframe:=4; max_blength:=4.5mm;
  defaultfont:="uhvr8r"; defaultsize:=8bp; defaultscale:=1;
}%
\begin{document}
\noindent%
%-----
\begin{mplibcode}
  fsize:=(50mm,50mm);
  beginfont("NO:1","EN:Limonin","MW:470.51",
    %-----
    ": <30,?6,{-3,-4}=?6,           ",
    ": -5=?3,-2=wf,-1=wb,6=?5,-4=?6,-5=wf, ",
    ": {13,15,17,20}:0,{3,12,21}://0,      ",
    ": {4~wf^60,8~zf^60,18^35,18^-35}:/_,  ",
    ": {1^60,5^180,16^60}:/*H,           ",
    ": @14,\*,|,?5,{1,4}=d1,3:0         ")
    %-----
  if check(mc)=0: MC(scantokens(mc)) fi
  endfont
\end{mplibcode}\\
%-----
\begin{mplibcode}
  fsize:=(80mm,50mm);
  beginfont("NO:2","EN:beta-carotene","MW:536.87",
    %-----
    ": <30,?6,3=d1,{3,5^35,5^-35}:/_,      ",
    ": @4,\,|,!18,{1,3,5,7,9,11,13,15,17}=dr, ",
    ": {3,7,12,16}:/_,                      ",
    ": |,?6,6=d1,{6,2^35,2^-35}:/_         ")
    %-----
  if check(mc)=0: MC(scantokens(mc)) fi
  endfont
\end{mplibcode}\\
%-----
\begin{mplibcode}
  fsize:=(50mm,50mm);
  beginfont("NO:3","EN:Gibberellin A3","MW:346.37",
    %-----
    ": <18,?5,3=?7,5=?6[12],              ",
    ": @8,160'1.3,&3,13=d1,6=wf,8=wb,      ",
    ": @5,40~zf'1,0,60,//0^180,&14~zb,    ",
    ": 2:/COOH,7://_,13:*/OH,8:*/OH,      ",
    ": 14:*/_,{1^60,4^60}:*/H             ")
    %-----
  if check(mc)=0: MC(scantokens(mc)) fi
endfont;
%-----
\end{mplibcode}\\
\end{document}

```

6.7 LaTeX file example

```

%-----
\documentclass[a4paper]{article}
\usepackage{graphicx}
\makeatletter%
%-----
\usepackage{mcf_setup}
%-----
\pagestyle{empty}
%-----
\def\put@char{%
  \begin{picture}(84,42)%
    \put(0,38){\bf [MOLnum]\EN{ }\small\tt/FM:\fm/MW:\mw}%
    \put(10,0){\font\@strufont=\File\relax%
      \hbox{\@strufont\char\Char}}%
  \end{picture}%
}%
\def\INFO#1{\@for\@temp:=#1\do{\tag@var\@temp}\put@char}%
\makeatother
%-----
\begin{document}
\unitlength=1mm%
\INFO{J:mcf_man_soc,C:141,NO:1,mw:349.40462,fm:C16H19N3O4S,EN:Ampicillin}%
\INFO{J:mcf_man_soc,C:142,NO:2,mw:386.6532,fm:C27H46O,EN:Cholesterol}%
\end{document}
%-----

```

[1]Ampicillin

FM:C16H19N3O4S MW:349.40462

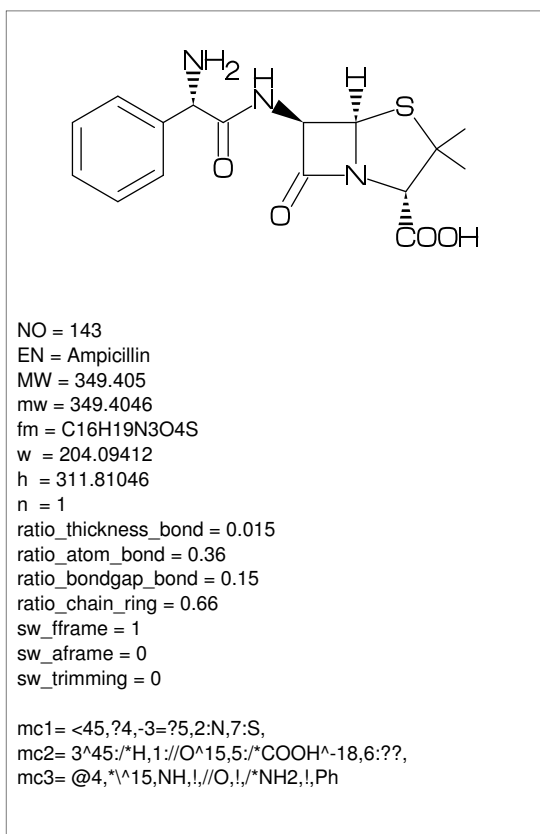

[2]Cholesterol

FM:C27H46O MW:386.6532

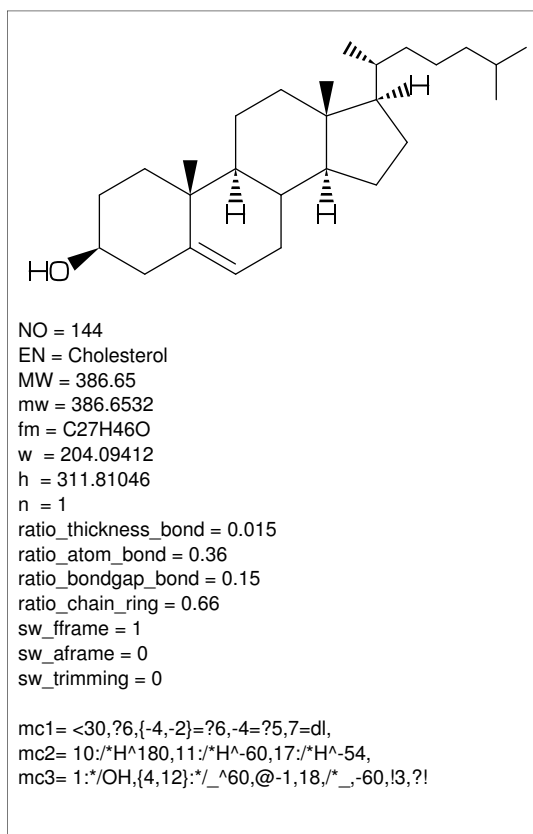

Index

!, 3
!!, 4
!!!, 4
, 7
**, 6, 12
*/, 6
/, 6
*\, 3
**, 3
/, 6
/*, 6, 12
//, 6
:, 5
?, 3
?!, 7
??, 7
??!, 7
@, 3
@(), 7
#, 4
##, 4
\$, 5
&, 3
~, 3, 6
~, 3, 4, 6
~~, 4
\, 3
*, 3
\,, 3
|, 5
||, 5
>, 3, 7
>>, 12
<, 6
' , 3, 4, 6

A[], 12
A[]ang, 12
A[]down, 12
A[]left, 12
A[]right, 12
A[]up, 12
add(), 12
An, 12
atomfont, 8
aux_delimiter, 17
aw, 12, 13

B[], 12
B[]ang, 12
B[]down, 12
B[]e, 12
B[]left, 12
B[]m, 12
B[]right, 12
B[]s, 12
B[]up, 12
bd, 4

bd_, 4
beginfont(), 11
blength, 8
blue, 8
Bn, 12
bz, 4

C, 17
check(), 11, 14
circlediam, 12
circlepen, 12

db, 4
defaultscale, 12, 13
dl, 4
dl_, 4
dm, 4
dm_, 4
dr, 4
dr_, 4
dt, 4

em, 12, 13
EN, 17
endfont, 11
ext(), 13
ext_clear, 13

FM, 17
fm, 17
fmargin, 9
fsize, 9

green, 8

h, 12, 17
h0, 13
hz, 7

J, 17
JN, 17

l, 12
labeloffset, 12
lonepair, 12
lonepairdiam, 12
lonepairspace, 12
lr, 7

mangle, 8
max_blength, 9
MC(), 11
MCat(), 11
mcf2graph.mf, 15
mcf_setup.sty, 21
MI, 17
mi, 17
minus, 12
mposition, 8

msize, 8
 MW, 17
 mw, 17

 n, 13
 N!, 7
 N!2, 7
 N?!, 7
 NH, 7
 NO, 17
 numberA, 10
 numberA_end, 10
 numberA_start, 10
 numberB, 10
 numberB_end, 10
 numberB_start, 10

 offset_atom, 9
 offset_bond_gap, 9
 offset_thickness, 9
 offset_wedge, 9

 p0, 12
 Ph, 6
 plus, 12

 ratio_atom_bond, 9
 ratio_atomgap_atom, 9
 ratio_bondgap_bond, 9
 ratio_chain_ring, 9
 ratio_char_bond, 9
 ratio_hashgap_bond, 9
 ratio_thickness_bond, 9
 ratio_thickness_char, 13
 ratio_wedge_bond, 9
 red, 8
 rl, 7

 si_, 4
 S0, 7
 S00, 7
 sw_iframe, 10
 sw_aux_out, 15
 sw_expand, 10
 sw_fframe, 10
 sw_file_open, 15
 sw_group_off, 10
 sw_mframe, 10
 sw_mol_out, 19
 sw_rep_out, 18
 sw_single, 10
 sw_trimming, 10

 tag, 15
 tm, 4

 USE, 17

 var, 15
 vb, 4
 vf, 4
 vt, 7

 w, 12, 17
 w0, 13
 wb, 4
 wb_, 4
 wf, 4
 wf_, 4
 wv, 4

 zb, 4
 zb_, 4
 zf, 4
 zf_, 4